



SOT-23-6L Plastic-Encapsulate MOSFETS

**MK6405**

**Single P-Channel 30-V(D-S) MOSFET**

V(BR)DSS	RDS(on)MAX	ID
-30 V	58mΩ@ -10V	-5A
	87mΩ@ -4.5V	

**FEATURE:**

※ TrenchFET Power MOSFET

**General Description :**

The MK6405 uses advanced trench technology to provide excellent RDS(ON) with low gate charge. This device is suitable for use as a load switch or in PWM applications. Standard Product MK6405 is Pb-free (meets ROHS & Sony 259 specifications).

**MARKING:**

**D5KB XX**

**Equivalent Circuit :**

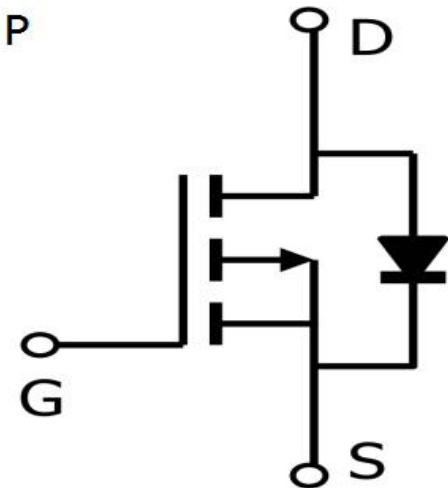

SOT-23-6L

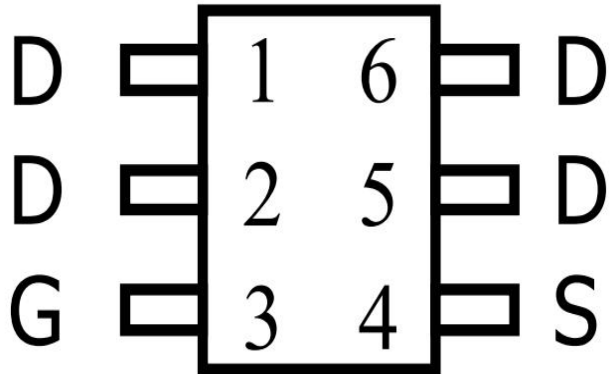

**Maximum ratings ( Ta=25°C unless otherwise noted)**

Parameter	Symbol	Value	Unit
Drain-Source Voltage	VDS	-30	V
Gate-Source Voltage	VGS	±20	
Continuous Drain Current	ID	-5	A
Pulsed Diode Current	IDM	-20	
Continuous Source-Drain Current(Diode Conduction)	IS	-2.8	
Power Dissipation	PD	2	W
Thermal Resistance from Junction to Ambient (t≤10s)	RθJA	110	°C/W
Operating Junction	TJ	150	°C
Storage Temperature	TSTG	-55~+150	°C



MOSFET ELECTRICAL CHARACTERISTICS

Static Electrical Characteristics (Ta = 25 °C Unless Otherwise Noted)

Parameter	Symbol	Test Condition	Min	Typ	Max	Unit
<b>Static</b>						
Drain-source breakdown voltage	V(BR)DSS	VGS = 0V, ID = -250μA	-30			V
Gate-source threshold voltage	VGS(th)	VDS =VGS, ID = -250μA	-1		-3	V
Gate-body leakage current	IGSS	VDS =0V, VGS = ±20V			±100	nA
Zero gate voltage drain current	IDSS	VDS = -24V, VGS =0V			-1	μA
Static Drain-Source On-Resistance	RDS(on)	VGS = -10V, ID = -5A		47	58	mΩ
		VGS = -4.5V, ID = -4A		60	87	mΩ
On state drain current	ID(on)	VGS = -10V, VDS= -5V	-20			A
Forward transconductance	gfs	VDS = -5V, ID = -5A		8.6		S
Diode forward voltage	VSD	IS= -1A,VGS=0V		-0.8	-1	V
Maximum Body-Diode Continuous Current	IS				-2.8	A
<b>Dynamic</b>						
Input capacitance	Ciss	VDS = -15V, VGS =0V, f=1MHz		700	840	pF
Output capacitance	Coss			120		pF
Reverse transfer capacitance	Crss			75		pF
Total gate charge	Qg	VDS = -15V, VGS = -10V, ID = -5A		14.7	18	nC
Gate-source charge	Qgs			2		nC
Gate-drain charge	Qgd			3.8		nC
Gate resistance	Rg	f=1MHz		10		Ω
<b>Switching</b>						
Turn-on delay time	td(on)	VDS= -15V RL= 3Ω, ID = -5A, VGS= -10V,Rg=3Ω		8.3		ns
Rise time	tr			5		ns
Turn-off delay time	td(off)			29		ns
Fall time	tf			14		ns
Body Diode Reverse Recovery Time	Trr	IF= -5A, dI/dt=100A/μs		23.5		ns
Body Diode Reverse Recovery Charge	Qrr	IF= -5A, dI/dt=100A/μs		13.4		nC

**Note :**

1. Repetitive Rating : Pulse width limited by maximum junction temperature.
2. Surface Mounted on FR4 Board, t < 10 sec.
3. Pulse Test : Pulse Width≤300μs, Duty Cycle ≤ 2%.
4. Guaranteed by design, not subject to production testing.



**SOT-23-6L PACKAGE OUTLINE DIMENSIONS:**

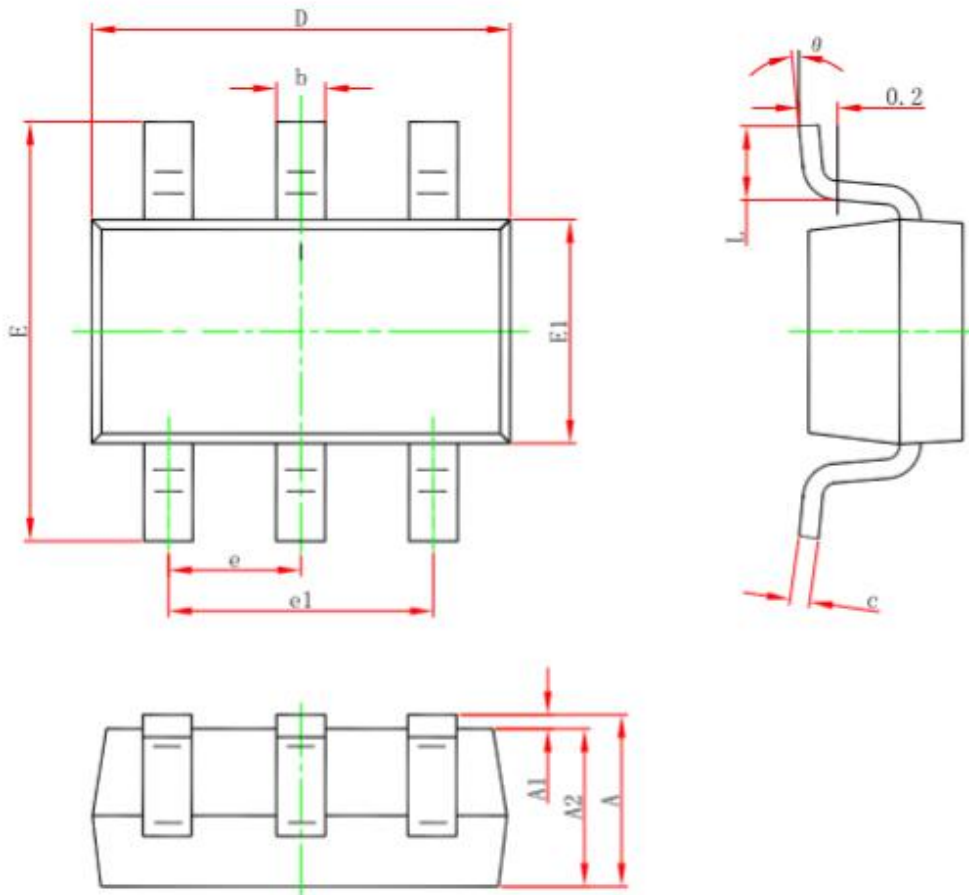

Symbol	Dimensions In Millimeters		Dimensions In Inches	
	Min.	Max.	Min.	Max.
A	1.050	1.250	0.041	0.049
A1	0.000	0.100	0.000	0.004
A2	1.050	1.150	0.041	0.045
b	0.300	0.500	0.012	0.020
c	0.100	0.200	0.004	0.008
D	2.820	3.020	0.111	0.119
E1	1.500	1.700	0.059	0.067
E	2.650	2.950	0.104	0.116
e	0.950(BSC)		0.037(BSC)	
e1	1.800	2.000	0.071	0.079
L	0.300	0.600	0.012	0.024
theta	0°	8°	0°	8°



Typical Electrical Thermal Characteristics:

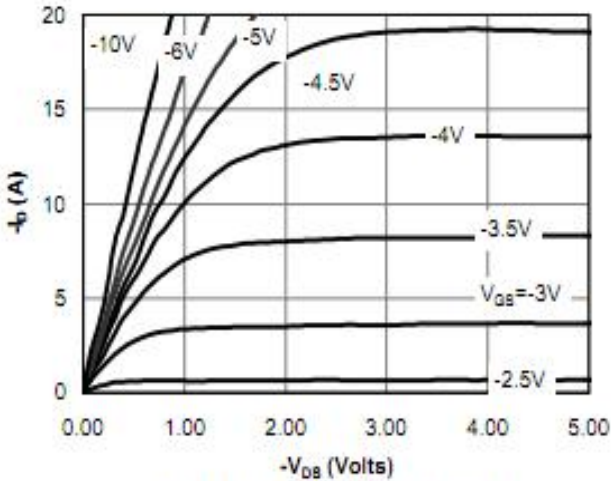

Figure 1: On-Region Characteristics

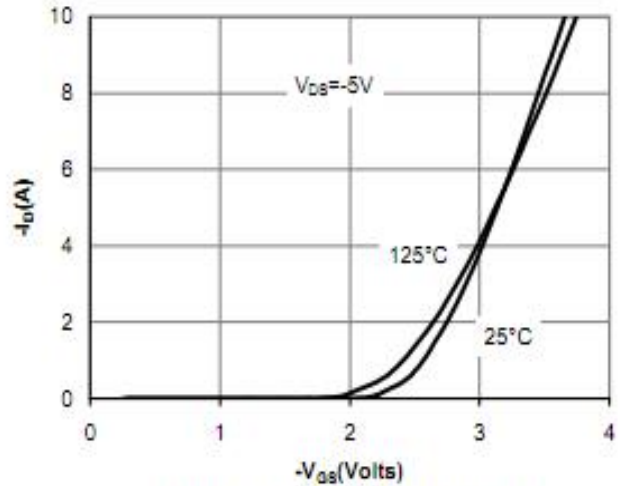

Figure 2: Transfer Characteristics

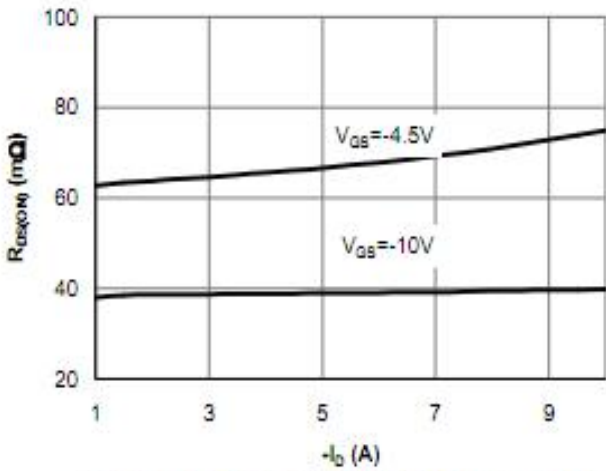

Figure 3: On-Resistance vs. Drain Current and Gate Voltage

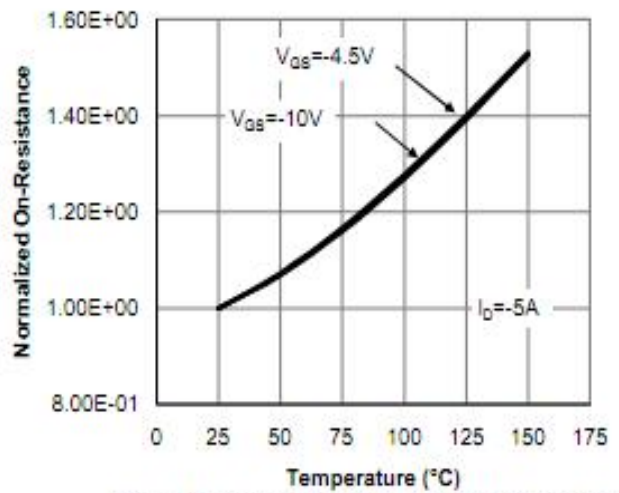

Figure 4: On-Resistance vs. Junction Temperature

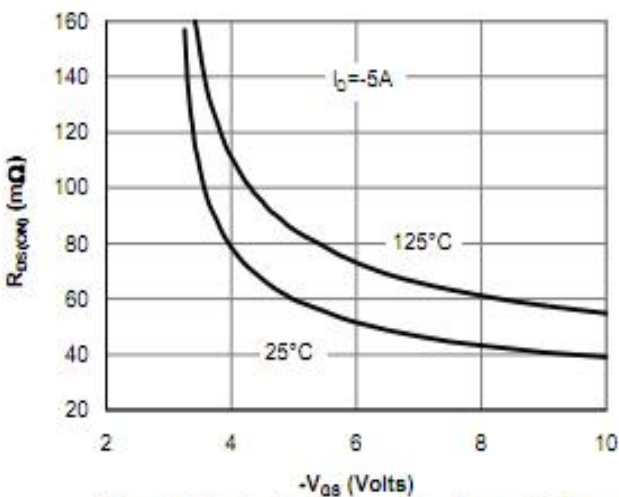

Figure 5: On-Resistance vs. Gate-Source Voltage

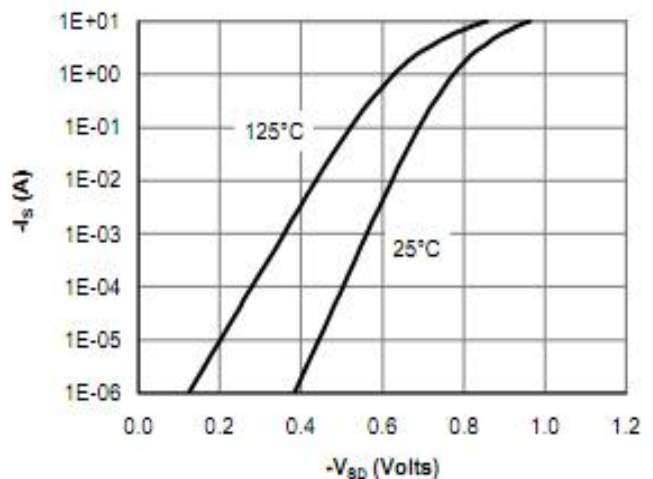

Figure 6: Body-Diode Characteristics



Typical Electrical Thermal Characteristics:

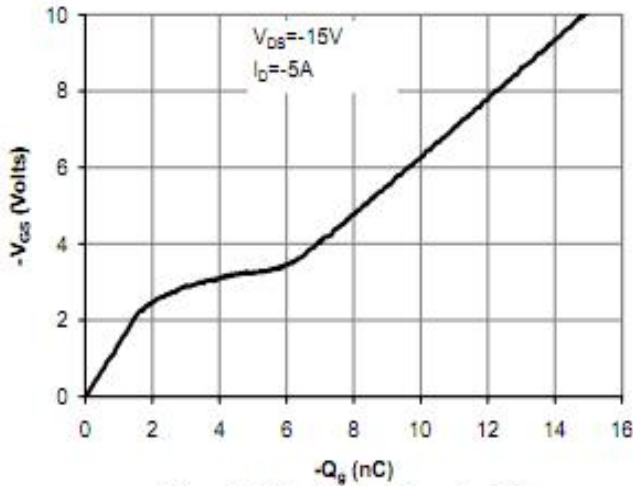

Figure 7: Gate-Charge Characteristics

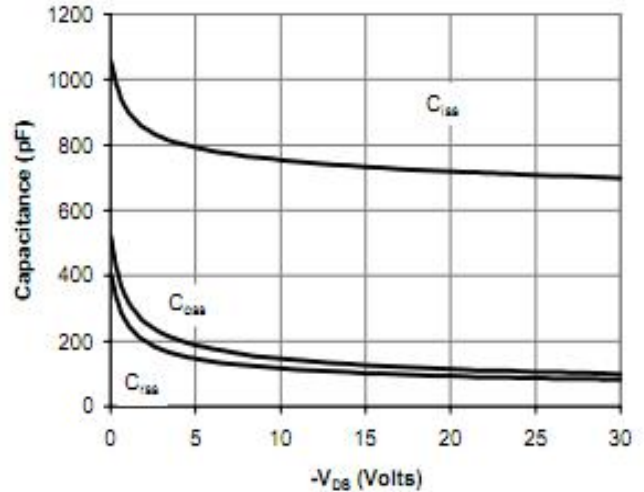

Figure 8: Capacitance Characteristics

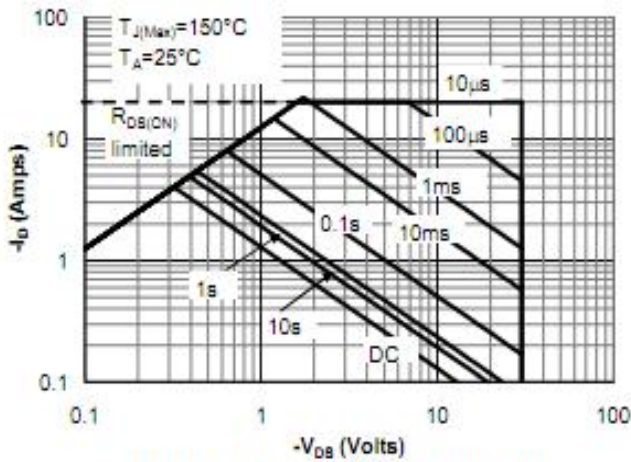

Figure 9: Maximum Forward Biased Safe Operating Area (Note E)

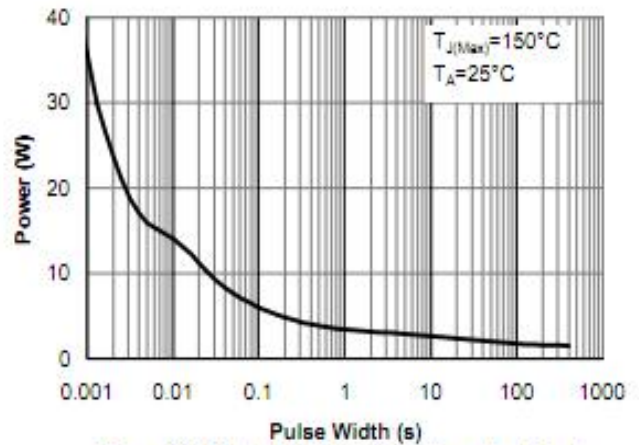

Figure 10: Single Pulse Power Rating Junction-to-Ambient (Note E)

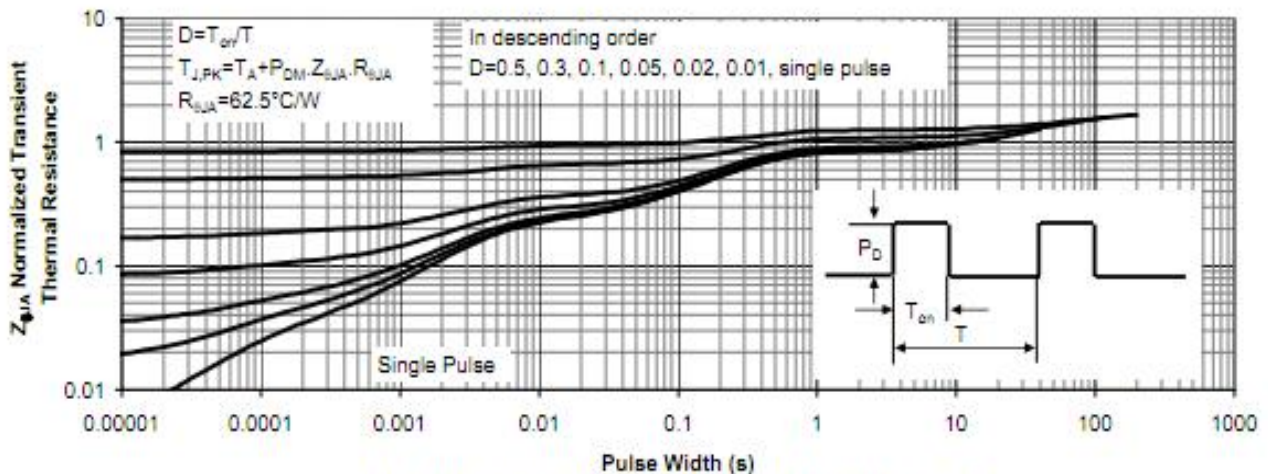

Figure 11: Normalized Maximum Transient Thermal Impedance